

BHH and BL Series Hydraulic Actuators

Designed for compactness and reliability



BETTIS™

EMERSON™

Quarter-Turn or Linear — Double-Acting or Spring-Return

“Operates in the toughest environments”

“Adapts and mounts to all types of valves”

“Small footprint is perfect for use in tight areas”

Bettis BHH and BHHF

Hydraulic double-acting and spring-return helical quarter-turn actuator.

Compact and concentric, the proven design provides space savings and reliability.

Using the multiple helical spline engagement with reciprocal splines on the piston, the high torque output is constant throughout the 90 degree rotations. Converts hydraulic energy into rotation, with torque output proportional to the supply pressure.

The BHH and BHHF can be operated in the most severe conditions, from high vibrations to severe environment locations.

Easily adapted to all types of quarter-turn valves, dampers or louvers. The mounting positions are numerous, with the models ready for direct mount modular control functions.

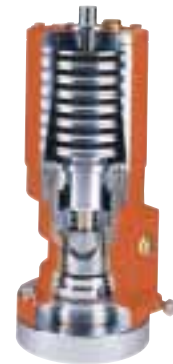

Bettis BL and BLF/BLFR

Hydraulic linear double-acting and spring-return actuator, with optional hand pump.

The BL and BLF convert hydraulic energy into linear motion, with thrust proportional to the supply pressure. With no external moving parts during operation, it includes in its design a pressure maintaining function against temperature variations.

Designed to adapt easily to most globe valves, it provides direct visual position indication and integrated crossover valve.

The design includes pressure maintaining functions which compensate for temperature fluctuations.

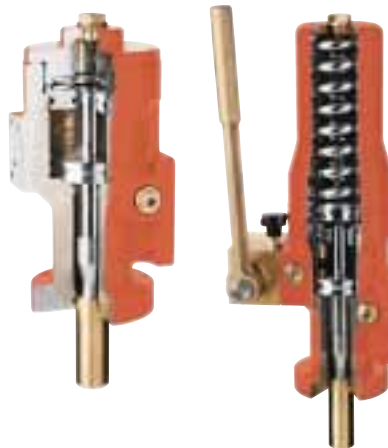

Block Types and Functions

Name	Block Function	Consequence
CB	Control Block	
2	2-Line Actuator (BHH Actuator)	
1	1-Line Actuator (BHFF Actuator)	
PCV	Pilot Operated Check Valve	Hydraulic lock of the piston on the actuator and prevent the actuator moving when it is required to be held stationary.
H	Quick Connection for Handpump	Used for emergency operation by means of a portable handpump on the actuator.
(H)	Connection for Auxiliary Handpump	Used for emergency operation by means of a portable handpump on the actuator.
S	Throttle/Stop Valve	Used to isolate the actuator if emergency operation is required.
T	Throttle	Control the speed of the actuators. Regulate flow in both directions.
R	Relief Valve	Releasing any overpressure in the actuator. The last chance filter is only for safety. Used on double acting actuators. When single acting actuator we don't need the release valve, because the oil can freely stream back from the actuator to the pipes, wherefore an overpressure is not possible.
NG6	Interface for CETOP 3 Valves	According to ISO 4401/NG6. NG6 and Cetop3 has the same connection.
NG3	Interface for NG3 Valves	Mounting a solenoid valve directly on the block or special function not build into blocks.
E	Interface for EL on/off or Potentiometer	To be used where there are no control components on the actuators, but EL indication is required.
1A	1-line (BHFF Fail Open)	Used instead of fail close - i.e. fire-fighting system. Can be used both to BHFF-FO and BL-FO.
F	Flush/Stop Valves	Flushing the pipe when starting up the hydraulic system to prevent impurity.
B	By-pass Hydraulic on/off indication	Connects actuator to pilot line in submerged or hazardous service.

Common Configurations

Block Type	PCV	H	(H)	S	T	R	NG6	E	1A	F
CB										
CB 1-S-H		X		X						
CB 1A-S-H		X		X					X	
CB 2-S				X						
CB2-S-H		X		X						
CB2-PCV-R-T	X				X	X				
CB2-PCV-R-T-H	X	X			X	X				
CB2-PCV-R-T-(H)	X		X		X	X				
CB-E										
CB1-S-H-E		X		X				X		
CB1A-S-H-E		X		X				X	X	
CB2-PCV-R-T-H-E	X	X			X	X		X		
CB2-PCV-R-T-(H)-E	X		X		X	X		X		
CB2-PCV-R-T-E	X				X	X		X		
CB2-S-H-E		X		X				X		
CB2-S-E				X				X		
CB-F										
CBF1-T-H-(E)		X		X			X	(X)		X
CBF1A-T-H-(E)		X		X			X	(X)	X	X
CBF2-PCV-T-R-H-(E)	X	X		X	X	X	X	(X)		X
CBF2-PCV-T-R-(H)-(E)	X		X	X	X	X	X	(X)		X
CBF2-PCV-T-R-(E)	X			X	X	X		(X)		X
CBF2-PCV-T-H-R-(E)		X		X	X	X		(X)		X
CBF2-T-E				X				(X)		X
CB-NG6										
CB1-NG6-S-H-(E)		X		X			X	(X)		
CB1A-NG6-S-H-(E)		X		X			X	(X)	X	
CB2-NG6-S-H-(E)		X		X			X	(X)		
CB2-NG6-S-E				X			X	(X)		
CBF-NG6										
CBF-2-NG6-PCV-R-T-H-(E)	X	X			X	X	X	(X)		X

Hydraulic Control Blocks

The Bettis control block system is designed for mounting on, or close to, the BHH, BHHF, BL and BLF actuators. For use with any of the actuators for conventional, submerged, or

hazardous location service, the actuator can be connected to the pilot line by means of a B-block.



CB Standard Block

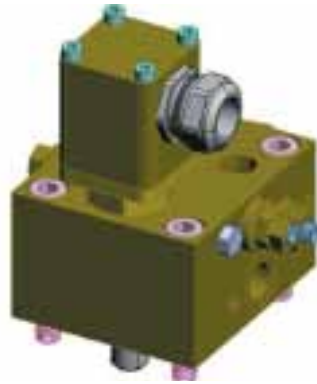

CBF Flushing Block

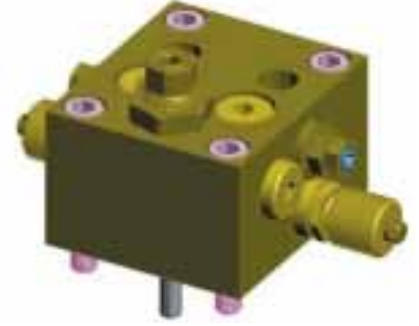

NG6 Block with Interface for CETOP 3 Valves

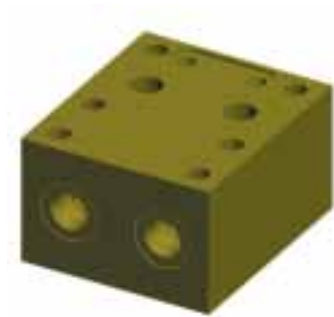

B Block

- Hydraulic Functions:**
- Pilot line connection
 - Flush system
 - Last chance filter
 - Throttle/stop valve
 - Pilot-operated check valve
 - Relief valve
 - Quick connections

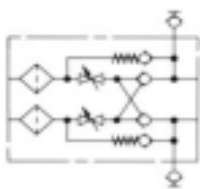

Basic Block

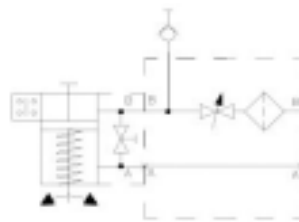

**Block for Single Acting
CBI-S-H**

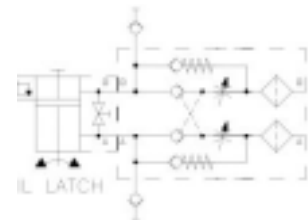

Block for Double Acting

Bettis BHH

Hydraulic Double-Acting Quarter-Turn Actuators



Technical Data

Working Pressure: 40-207 bar / 580-3000 psi
 Test Pressure: 1.5 x working pressure to a maximum of 250 bar / 3600 psi
 Temperature Range: -20° to +80° C / -5° to +180° F
 Low Temperature: Consult Factory
 Angle of Rotation: 90°
 Torque Range: 1000 to 142000 lb/in at 2000 psi
 Viscosity of Hydraulic Oil: 15 to 200 cSt

Features

- ATEX Certified
- Smallest footprint to torque ratio
- Compact & concentric design
- Balanced helical design eliminates side loading on valve assembly and stem
- High water ingress protection-IP68
- Integrated crossover valve
- Vibration resistant design
- Easy adaption standard valve bonnet design
- Unlimited mounting positions with built-in position adjustments
- Design ready for control functions

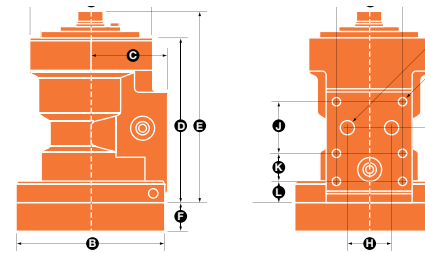

Weight	lb	kg
Displacement	cu.in.	litres
Dimensions	inches	mm

Model	Weight	Displacement	Dimensions Side View							Dimensions Front View					N		P	
			A	B	C	D	E	F	G	H	J	K	L	M	Thread	Depth	Thread	Depth
BHH 125	12	2	3.46	3.78	2.09	4.33	5.08	0.81	2.05	1.38	1.61	0.87	0.57	2.28	1/4" BSP	0.51	M8	0.47
	5.3	0.026	88	96	53	110	129	20.5	52	35	41	22	14.5	58	1/4" BSP	13	M8	12
BHH 250	18	3	4.09	4.65	2.36	5.14	5.96	0.91	2.05	1.38	1.61	0.87	0.65	2.32	1/4" BSP	0.51	M8	0.47
	8.3	0.05	104	118	60	130.5	151.5	23	52	35	41	22	16.5	59	1/4" BSP	13	M8	12
BHH 500	29	6	4.96	5.20	2.87	6.02	6.93	0.91	2.05	1.38	1.61	0.87	0.79	2.46	1/4" BSP	0.51	M8	0.47
	13	0.102	126	132	73	153	176	23	52	35	41	22	20	62.5	1/4" BSP	13	M8	12
BHH 1000	44	13	5.71	6.30	3.35	6.20	7.91	1.10	2.05	1.38	1.61	0.87	0.93	2.60	1/4" BSP	0.51	M8	0.47
	19.9	0.209	145	160	85	157.5	201	28	52	35	41	22	23.5	66	1/4" BSP	13	M8	12
BHH 2000	73	24	6.77	7.56	3.82	8.35	9.21	1.46	2.05	1.38	1.61	0.87	1.00	2.68	1/4" BSP	0.51	M8	0.47
	33.1	0.4	172	192	97	212	234	37	52	35	41	22	25.5	68	1/4" BSP	13	M8	12
BHH 4000	152	49	8.46	11.81	4.92	10.04	10.98	1.57	2.05	1.38	1.61	0.87	1.24	2.91	1/4" BSP	0.51	M8	0.47
	68.9	0.8	215	300	125	255	279	40	52	35	41	22	31.5	74	1/4" BSP	13	M8	12
BHH 8000	238	98	9.92	12.36	6.18	12.56	13.23	1.73	2.05	1.38	1.61	0.87	1.85	3.52	1/4" BSP	0.51	M8	0.47
	108	1.6	252	314	157	319	336	44	52	35	41	22	47	89.5	1/4" BSP	13	M8	12
BHH 16000	387	189	11.81	13.78	7.09	15.35	16.14	2.36	2.05	1.38	1.61	0.87	2.42	4.09	1/4" BSP	0.51	M8	0.47
	176	3.1	300	350	180	390	410	60	52	35	41	22	61.5	104	1/4" BSP	13	M8	12

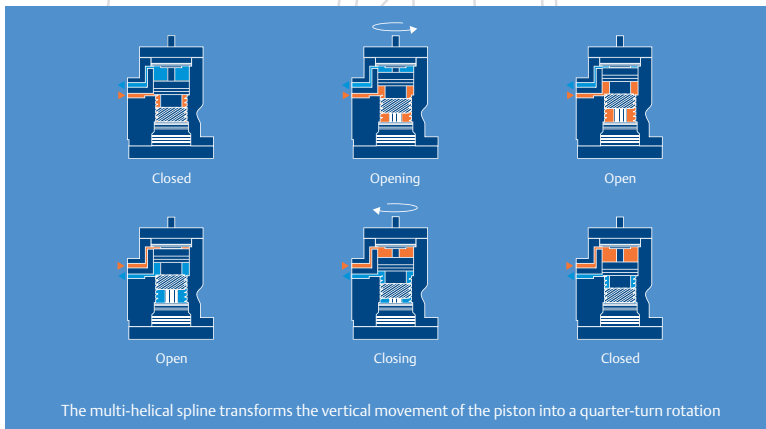

Valve spindle options:
 Limits for machining of the adaptor. Other shapes and valve shaft intrusions on request, please contact Bettis.

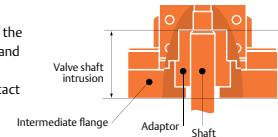

Model	DIN 6885		DIN 79		Valve Shaft Intrusion	
	in (max.)	mm (max.)	in (max.)	mm (max.)	in	mm
BHH 125	0.669	17	0.630	16	1.77	45
BHH 250	0.984	25	0.945	24	1.97	50
BHH 500	1.378	35	1.181	30	2.17	55
BHH 1000	1.654	42	1.417	36	2.48	63
BHH 2000	2.283	58	1.969	50	2.95	75
BHH 4000	2.913	74	2.480	63	3.35	85
BHH 8000	3.740	95	3.150	80	4.13	105
BHH 16000	3.740	95	3.543	90	5.20	132

Bettis BHHF

Hydraulic Single-Acting Quarter-Turn Helical Actuators

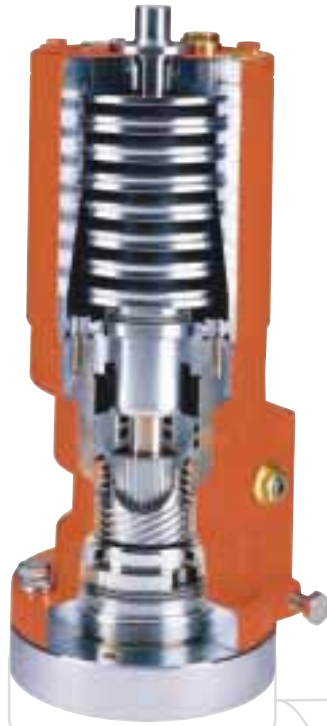

Technical Data

Working pressure: 90 to 202 bar / 1500 to 3000 psi
 Test pressure: 1.5 x working pressure to a maximum of 250 bar / 3600 psi
 Temperature range: -20 °C to +80 °C / -5 °F to +180 °F
 Low Temperature: Consult Factory
 Angle of rotation: 90 °
 End closing torque: 30 to 4800 Nm / 265 to 43000 lb/in
 Viscosity of hydraulic oil: 15 to 200 cSt

Features

- Available with choice of 1500 psi / 90 bar or 2000 psi / 135 bar spring set (SR1 & SR2)
- ATEX certified
- Smallest footprint to torque ratio
- Compact & concentric design
- Spring action by means of dished springs
- Balanced helical design eliminates side loading on valve assembly and stem
- High water ingress protection-IP68
- Integrated crossover design
- Easy adaption standard valve bonnet design
- Vibration resistant design
- Unlimited mounting positions with built-in position adjustments

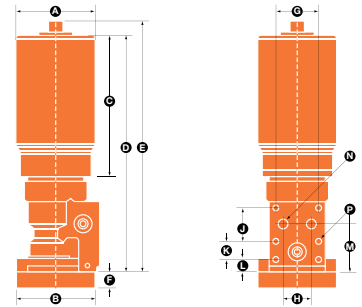

Weight	lb	kg
Displacement	cu.in.	litres
Dimensions	inches	mm

Model	Weight	Displacement	Dimensions Side View							Dimensions Front View					N		P	
			A	B	C	D	E	F	G	H	J	K	L	M	Thread	Depth	Thread	Depth
BHHF 125	19	2	3.66	3.78	3.62	7.95	8.78	0.81	2.05	1.38	1.61	.087	.057	2.28	1/4" BSP	0.51	M8	0.47
	8.6	0.026	93	96	92	202	223	20.5	52	35	41	22	14.5	58	1/4" BSP	13	M8	12
BHHF 250	30	3	4.25	4.65	4.72	9.88	10.71	0.91	2.05	1.38	1.61	.087	0.65	2.32	1/4" BSP	.051	M8	0.47
	13.6	0.05	108	118	120	251	272	23	52	35	41	22	16.5	59	1/4" BSP	13	M8	12
BHHF 500	50	6	5.35	5.20	5.91	11.93	12.76	0.91	2.05	1.38	1.61	0.87	0.79	2.46	1/4" BSP	0.51	M8	0.47
	22.5	0.102	136	132	150	303	324	23	52	35	41	22	20	62.5	1/4" BSP	13	M8	12
BHHF 1000	86	13	6.46	6.30	6.89	13.94	14.76	1.10	2.05	1.38	1.61	0.87	0.93	2.60	1/4" BSP	0.51	M8	0.47
	39.1	0.209	164	160	175	354	375	28	52	35	41	22	23.5	66	1/4" BSP	13	M8	12
BHHF 2000	147	24	7.68	7.56	8.23	16.57	17.40	1.46	2.05	1.38	1.61	0.87	1.00	2.68	1/4" BSP	0.51	M8	0.47
	66.7	0.4	195	192	209	421	442	37	52	35	41	22	25.5	68	1/4" BSP	13	M8	12
BHHF 4000	334	49	9.84	11.81	11.18	21.22	22.05	1.57	2.05	1.38	1.61	0.87	1.24	2.91	1/4" BSP	0.51	M8	0.47
	151.8	0.8	250	300	284	539	560	40	52	35	41	22	31.5	74	1/4" BSP	13	M8	12
BHHF 8000	638	98	12.20	12.36	15.75	27.40	28.19	1.73	2.05	1.38	1.61	0.87	1.85	3.48	1/4" BSP	0.51	M8	0.47
	290	1.6	310	314	400	696	716	44	52	35	41	22	47	88.5	1/4" BSP	13	M8	12
BHHF 16000	1027	189	14.57	13.78	22.52	36.46	37.28	2.36	2.05	1.38	1.61	0.87	2.42	4.09	1/4" BSP	0.51	M8	0.47
	467	3.1	370	350	572	926	947	60	52	35	41	22	61.5	104	1/4" BSP	13	M8	12

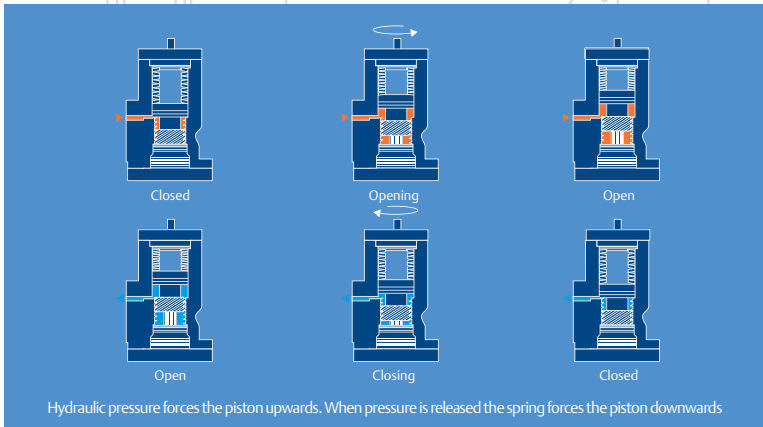

Valve spindle options:
 Limits for machining of the adaptor. Other shapes and valve shaft intrusions on request, please contact Bettis.

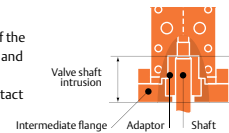

Model	DIN 6885		DIN 79		Shaft Intrusion	
	in (max.)	mm (max.)	in (max.)	mm (max.)	in	mm
	BHHF 125	0.669	17	0.630	16	1.77
BHHF 250	0.984	25	0.945	24	1.97	50
BHHF 500	1.378	35	1.181	30	2.17	55
BHHF 1000	1.654	42	1.417	36	2.48	63
BHHF 2000	2.283	58	1.969	50	2.95	75
BHHF 4000	2.913	74	2.480	63	3.35	85
BHHF 8000	3.740	95	3.150	80	4.13	105
BHHF 16000	3.740	95	3.543	90	5.20	132

Hand Pumps

Hand pumps can be installed on all standard actuators – BHH, BHHF, BL, BLF. They are available for use with single acting or double acting configurations.

Depending on the actuator size, control type and valve location, the hand pumps can be used for emergency operation and standalone operation without other remote facilities.



Direct Mounted Hand Pump

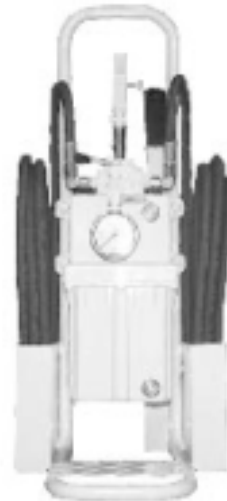

Portable Hand Pump

Valve Position Indicators

The Bettis Valve Position Indicators (VPI) program is designed to locally or remotely indicate the position of hydraulically-operated actuators with determined displacement. It continuously indicates valve position by measuring the actual oil flow to and from the actuator. It can also include temperature and

pressure compensation blocks. When placed remotely from the actuator, the VPI can indicate valve position when the actuator is submerged or in a hazardous area.



VPI



VPI with temperature and pressure compensation blocks & solenoids

Other Options Available

- Hydraulic on/off indication
- Submersion cover
- Epoxy coating
- Flushing option without disconnection

- Low temperature—Consult Factory
- Solenoid solutions
- Intelligent hydraulic positioner

Bettis BLF

Single-Acting Linear Actuator



Technical Data

Working pressure: 135 bar / 2000 psi
 Test pressure: 1.5 x working pressure to a maximum of 250 bar / 3600 psi
 Temperature range: -20° to +80°C / -5° to +180°F
 End closing thrust (spring): 1500 - 16500 N / 1100 to 12000 lbf
 Viscosity of hydraulic oil: 15 to 200 cSt

The Bettis BLF/BLFR actuator for fail close operation of globe valves

Features

- Unique and simple design with integrated crossover valve
- Easy installation on intermediate flange of globe valve
- Same unit for various valve sizes
- Water ingress protection - IP68
- No external moving parts
- Design ready for control functions
- Built-in hydraulic emergency operation for the BLFR
- Direct visual indication

Thrust	lbf	N
Weight	lb	kg
Displacement	cu.in.	litres
Dimensions	inches	mm

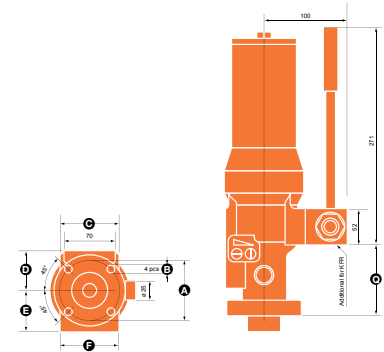

Model	End Closing Thrust	Stroke	Weight	Displacement	Dimensions Bottom View						Dimensions Front View														
					A	B	C	D	E	F	G	H	I	J	K	L	M	N	O	P	Q	R	S	T	U
BLF 65	337	0.64	13	1.28	2	0	3.15	1.87	-	-	1.36	1.42	2.99	0.67	0.59	6.30	8.86	2.52	3.15	0.79	-	0.36	1.32	0.87	2.48
	1500	16.25	6	0.021	62	9	80	47.5	-	-	34.5	36	76	17	15	160	225	64	80	20	-	9	33.5	22	63
BLF 125	1079	1.23	24	5.00	3	0	3.07	1.97	2.05	2.83	1.67	1.65	3.54	0.75	0.79	8.23	13.58	3.15	3.84	0.98	3.50	0.36	1.32	0.87	2.48
	4800	31.25	11	0.082	75	9	78	50	52	72	42.5	42	90	19	20	209	345	80	97.5	25	89	9	33.5	22	63
BLF 250	3709	2.46	112	26.12	5	1	2.76	3.31	3.07	2.83	2.91	2.83	5.51	0.91	1.38	12.95	23.70	5.91	6.10	1.97	6.10	0.36	1.32	0.87	2.48
	16500	62.5	51	0.428	118	14	70	84	78	72	74	72	140	23	35	329	602	150	155	50	155	9	33.5	22	63

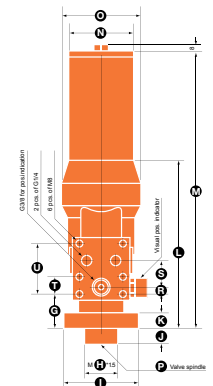
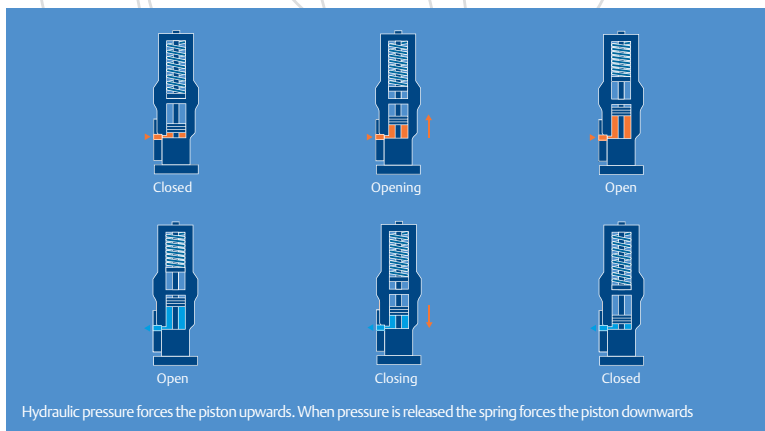

Torque Ratings – BHH/BHMF Series – Imperial

BHH – Double Acting

Actuator Model		Operating Pressure (psi)								
		500	750	1000	1250	1500	1750	2000	2500	3000
		Hydraulic Torque Output, lb/in								
BHH 125		283	407	575	735	859	982	1106	1390	1699
BHH 250		575	814	1142	1469	1717	1965	2213	2779	3390
BHH 500		1142	1637	2292	2947	3434	3930	4425	5567	6780
BHH 1000		1965	3275	4585	5895	6877	7859	8851	11143	13568
BHH 2000		4585	6550	9178	11798	13763	15728	17701	22286	27136
BHH 4000		9178	13108	18356	23596	27535	31464	35403	44581	54282
BHH 8000		18356	26216	36713	47201	55069	62938	70806	89162	108563
BHH 16000		36713	52441	73426	94402	110139	125875	141612	178325	217135

BHMF – Single Acting

Actuator Model		Spring Torque	Operating Pressure (psi)								
			500	750	1000	1250	1500	1750	2000	2500	3000
			Hydraulic Torque Output, lb/in								
BHMF 125-SR1	Start	336			230	398	522	646	770		
	End	186			27	195	319	443	566		
BHMF 125-SR2	Start	549				407	531	655	779	1062	1372
	End	266				44	168	292	416	699	1009
BHMF 250-SR1	Start	620			425	752	1000	1248	1487		
	End	416			204	531	779	1027	1266		
BHMF 250-SR2	Start	1354					832	1080	1328	1859	2505
	End	575					35	212	460	1036	1637
BHMF 500-SR1	Start	1319			947	1602	2098	2584	3080		
	End	903			487	1142	1637	2124	2620		
BHMF 500-SR1	Start	2584					1682	2168	2664	3815	5027
	End	1239					239	726	1221	2372	3585
BHMF 1000-SR1	Start	2797			1921	3231	4204	5195	6187		
	End	1841			855	2195	3177	4160	5142		
BHMF 1000-SR2	Start	5372				2788	3770	4753	5735	8028	10453
	End	2832				221	1204	2186	3169	5461	7231
BHMF 2000-SR1	Start	5585			3824	6443	8408	10373	12347		
	End	3363			1903	4523	6488	8452	10426		
BHMF 2000-SR2	Start	8922				4806	6780	8745	10709	15303	20153
	End	5355				805	2779	4744	6709	11302	16153
BHMF 4000-SR1	Start	11134			8364	13612	17542	21481	25410		
	End	7125			4027	9276	13205	17144	21074		
BHMF 4000-SR2	Start	22569					13373	17312	21242	30420	40120
	End	11949					540	4478	8408	17586	27287
BHMF 16000-SR1	Start	42484					26747	34615	42484	60840	80250
	End	21242					5505	10718	21242	39598	59008
BHMF 16000-SR2	Start	73461					53494	69231	84967	121680	160491
	End	42484					11010	26747	42484	79196	118007

Torque Ratings – BHH/BHHF Series – Metric

BHH – Double Acting

Actuator Model		Operating Pressure (bar)								
		35	50	70	90	105	120	135	170	207
		Hydraulic Torque Output, Nm								
BHH 125		32	46	65	83	97	111	125	157	192
BHH 250		65	92	129	166	194	222	250	314	383
BHH 500		129	185	259	333	388	444	500	629	766
BHH 1000		222	370	518	666	777	888	1000	1259	1533
BHH 2000		518	740	1037	1333	1555	1777	2000	2518	3066
BHH 4000		1037	1481	2074	2666	3111	3555	4000	5037	6133
BHH 8000		2074	2962	4148	5333	6222	7111	8000	10074	12266
BHH 16000		4148	5925	8296	10666	12444	14222	16000	20148	24533

BHHF – Single Acting

Actuator Model		Spring Torque	Operating Pressure (bar)								
			35	50	70	90	105	120	135	170	207
			Hydraulic Torque Output, Nm								
BHHF 125-SR1	Start	38			26	45	59	73	87		
	End	21			3	22	36	50	64		
BHHF 125-SR2	Start	62				46	60	74	88	120	155
	End	30				5	19	33	47	79	114
BHHF 250-SR1	Start	70			48	85	113	141	168		
	End	47			23	60	88	116	143		
BHHF 250-SR2	Start	153					94	122	150	210	283
	End	65					4	24	52	117	185
BHHF 500-SR1	Start	149			107	181	237	292	348		
	End	102			55	129	185	240	296		
BHHF 500-SR1	Start	292					190	245	301	431	568
	End	140					27	82	138	268	405
BHHF 1000-SR1	Start	316			217	365	475	587	699		
	End	208			100	248	359	470	581		
BHHF 1000-SR2	Start	607				315	426	537	648	907	1181
	End	320				25	136	247	358	617	817
BHHF 2000-SR1	Start	631			432	728	950	1172	1395		
	End	380			215	511	733	955	1178		
BHHF 2000-SR2	Start	1008				543	766	988	1210	1729	2777
	End	605				91	314	536	758	1277	1825
BHHF 4000-SR1	Start	1258			945	1538	1982	2427	2871		
	End	805			455	1048	1492	1937	2381		
BHHF 4000-SR2	Start	2550					1511	1956	2400	3437	4533
	End	1350					61	506	950	1987	3083
BHHF 16000-SR1	Start	4800					3022	3911	4800	6874	9067
	End	2400					622	1211	2400	4474	6667
BHHF 16000-SR2	Start	8300					6044	7822	9600	13748	18133
	End	4800					1244	3022	4800	8948	13333

Bettis BL

Hydraulic Double-Acting Linear Actuators

Technical Data

Working pressure: 135 bar / 2000 psi

Test pressure: 1.5 x working pressure to a maximum of 250 bar / 3600 psi

Temperature range: -20° to +80° C / -5° to +180° F

Closing thrust: 17000 - 92500 N / 12500-68000 lbf

Viscosity of hydraulic oil: 15 to 200 cSt

For intermediate position and fail set operation for globe valves

Features

- Unique and simple design with integrated crossover valve
- Easy installation on intermediate flange of globe valve
- Same unit for various size valves
- Water ingress protection - IP68
- No external moving parts
- Design ready for control functions
- Direct visual indication
- Integrated anti-creep design

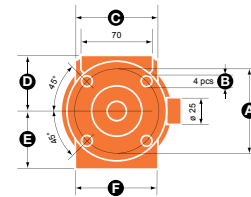

Thrust	lbf	N
Weight	lb	kg
Displacement	cu.in.	litres
Dimensions	inches	mm

Model	Thrust at 1550 psi (108 bar)	Thrust at 1950 psi (135 bar)	Stroke	Weight	Displacement	Dimensions Bottom View						Dimensions Front View													
						A	B	C	D	E	F	G	H	I	J	K	L	M	N	O	P	R	S	T	U
BL 65	3057	3822	0.64	10	1	2.44	0.35	3.15	1.87	-	-	1.36	1.42	2.99	0.67	0.59	6.02	6.22	-	3.15	0.79	0.36	1.32	0.87	2.48
	13600	17000	16.25	4.5	0.021	62	9	80	47.5	-	-	34.5	36	76	17	15	153	158	-	80	20	9	33.5	22	63
BL 125	6295	7868	1.23	15	5	2.95	0.35	3.07	1.97	2.05	2.83	1.67	1.65	3.54	0.75	0.79	7.44	7.95	1.77	3.84	0.98	0.36	1.32	0.87	2.48
	28000	35000	31.25	7	0.082	75	9	78	50	52	72	42.5	42	90	19	20	189	202	45	97.5	25	9	33.5	22	63
BL 250	16636	20795	2.46	53	26	4.65	0.55	2.76	3.31	3.07	2.83	2.91	2.83	5.51	0.91	1.38	11.77	12.64	3.15	6.10	1.97	0.36	1.32	0.87	2.48
	74000	92500	62.5	24	0.428	118	14	70	84	78	72	74	72	140	23	35	299	321	80	155	50	9	33.5	22	63

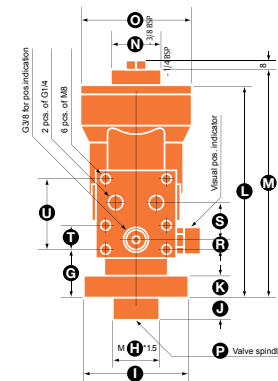
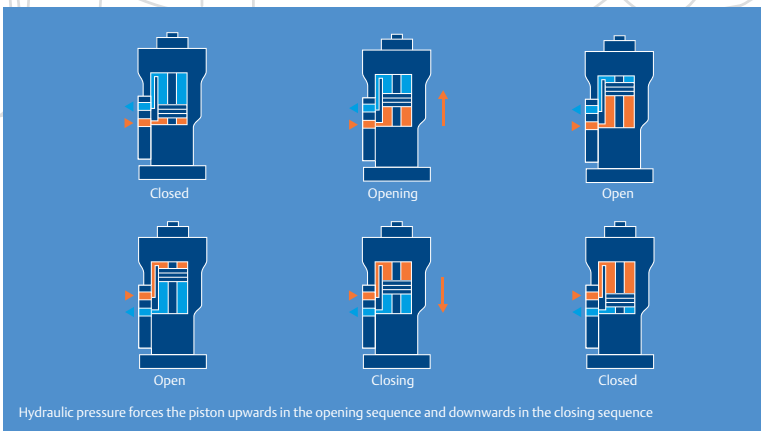

Bettis — Solutions for All of Your Actuator Needs

Contact Us: Emerson Process Management, Valve Automation facilities at your nearest location:

World Area Configuration Centers (WACC) offer sales support, service, inventory and commissioning to our global customers. Choose the WACC or sales office nearest you:

NORTH & SOUTH AMERICA

19200 Northwest Freeway
Houston, TX 77065
USA
T +1 281 477 4100
F +1 281 477 2809

Av. Hollingsworth,
325, Iporanga Sorocaba
SP 18087-105
Brazil
T +55 15 3238 3788
F +55 15 3228 3300

ASIA PACIFIC

No. 9 Gul Road
#01-02 Singapore 629361
T +65 6501 4600
F +65 6268 0028

No.1 Lai Yuan Road
Wuqing Development Area
Tianjin 301700
P.R.China
T +86 22 8212 3300
F +86 22 8212 3300

MIDDLE EAST & AFRICA

P. O. Box 17033
Dubai
United Arab Emirates
T +971 4 811 8100
F +971 4 886 5465

P. O. Box 10305
Jubail 31961
Saudi Arabia
T +966 3 340 8650
F +966 3 340 8790

24 Angus Crescent
Longmeadow Business Estate
East P.O. Box 6908;
Greenstone; 1616
Modderfontein, Extension 5
South Africa
T +27 11 451 3700
F +27 11 451 3800

EUROPE

Berenyi u. 72-100
Videoton Industry Park
Building #230
Székesfehérvár 8000
Hungary
T +36 22 53 09 50
F +36 22 54 37 00

For complete list of sales and manufacturing sites, please visit www.emerson.com/actuationtechnologieslocations
Or contact us at info.actuationtechnologies@emerson.com

www.emerson.com/bettis

©2018 Emerson. All rights reserved.

The Emerson logo is a trademark and service mark of Emerson Electric Co. Bettis is a mark of the Emerson family of companies. All other marks are property of their respective owners.

The contents of this publication are presented for information purposes only, and while every effort has been made to ensure their accuracy, they are not to be construed as warranties or guarantees, express or implied, regarding the products or services described herein or their use or applicability. All sales are governed by our terms and conditions, which are available on request.

We reserve the right to modify or improve the designs or specifications of our products at any time without notice.

BETTIS[™]

www.emerson.com/bettis

EMERSON[™]